

Security System Control

DISCOVERY  **1000**

Specifications and Hookup

Introduction

The D1000 Series Security Control incorporates today's most desired operational features including upload/download, dual reporting, EEPROM memory, advanced lightning/transient protection and ease of user operation, all in an attractively priced package. The control is shipped with a factory basic program. Three definable panic zones are accessible through D1000 Series keypads. Two high current and two low current outputs are programmable to provide +12 VDC upon any alarms, or to selected non-alarm conditions.

Non-volatile EEPROM (electrically erasable programmable read only memory), allows the control to be easily programmed, eliminating the need to burn PROMS. The EEPROM maintains its data even with power disconnected. A watchdog circuit monitors the microprocessor and assures operational integrity of the system. The control may be programmed remotely with the aid of a personal computer and Hayes modem using the TRANSPORT PC software package.

The D1000 Series keypads feature easy to read numbers, a green indicator for READY status and a red indicator for ARMED status. The control may also be armed/disarmed with a momentary or shunt type key switch. Arming/Disarming the system can be easily accomplished by entering a four digit code.

This product has been carefully inspected to comply with rigid quality control standards before shipment to you. You will find that with reasonable care, it will provide years of reliable performance. Proper installation and regular maintenance by the installing company and frequent testing by the user are essential to assure continuous satisfactory operation of any alarm system.

LIMITATIONS

The D1000 Series is designed as part of a system designated to warn against unauthorized entry or of other situations. However, it is not a guarantee of protection against the occurrence of those events. Any alarm system is subject to compromise or failure to warn for various reasons: Unauthorized access can be gained through unprotected points or by disarming or bypassing protected points. Sensing devices are power driven and will not operate without electrical power. Telephone lines over which alarm signals are transmitted may be out of service or rendered inoperable by an intruder. Smoke detectors have limitations and cannot detect all types of fires or sense smoke out of the effective range of the detector.

ALL RIGHTS RESERVED

No part of this publication may be reproduced, stored in a retrieval system, or transmitted in any form or by any means — electronic, mechanical, photocopying, recording, or otherwise without the prior written permission of the manufacturer. The material in this publication is for information purposes and subject to change without notice. The manufacturer assumes no responsibility for any errors which may appear in this publication. Printed in U.S.A.

ff SPECIAL NOTE referencing the word "Fire" in this manual.

Use of this control for fire detection and/or announcement may not be permitted by certain states, counties, municipalities, or local jurisdiction. It is the responsibility of the installing alarm company to check with their local A.H.J. (Authority Having Jurisdiction) or State Fire Marshals' office prior to using this control for fire.

Table Of Contents

Chapter 1. Installation And Wiring

1.1 Planning The Installation	1-1
1.2 Parts Diagram & Descriptions	1-3
1.3 Mounting And Wiring Preparation	1-4
1.4 Wiring	1-4

Chapter 2. Operating The System

2.1 Powering Up The Control	2-1
2.2 The D1000 Series Keypad	2-3

Chapter 3. D1000 Specifications

3.1 Technical Specifications	3-1
3.2 Features	3-2
3.3 Optional Accessories	3-4

Chapter 4. U.L. And N.F.P.A. Requirements

4.1 Underwriters Laboratories (U.L.) Listing	4-1
4.2 National Fire Protection Association (N.F.P.A.) Rules	4-1

Index

THIS PAGE INTENTIONALLY LEFT BLANK

Installation And Wiring **1**

1.1 Planning The Installation

The first step in any multi-zone security system installation is planning the job.

1. **Read through this entire manual** to familiarize yourself with all system features and procedures before actually beginning the installation. Section 4 contains information regarding Underwriters Laboratories (U.L.) and N.F.P.A. requirements.
2. Perform a physical survey of the installation site.
3. Discuss the installation requirements and applications with the customer.
4. Compare the installation requirements and applications. Refer to the D1000 Programmer's Manual for any changes that are required to meet specific installation requirements.
5. Bench test the system prior to installation.

NOTE

FIGURE 1-1 on page 1-2 details typical fire and burglar installation layouts. This can be used as a guide in planning the specific installation.

TYPICAL FIRE INSTALLATION LAYOUT

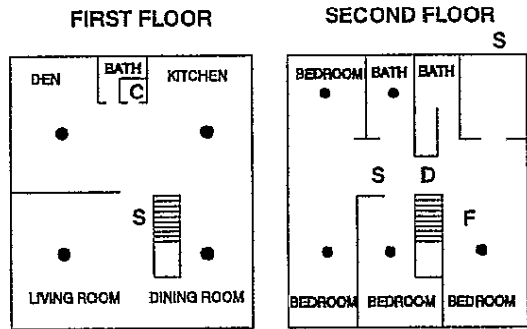

Note: Alternate locations may be required for the devices indicated.

TYPICAL BURGLAR INSTALLATION LAYOUT

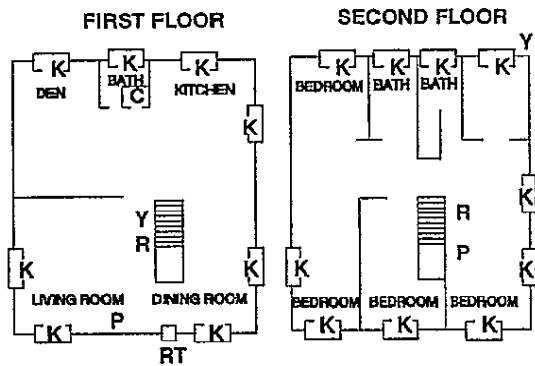

Note: All perimeter openings below 18" should be provided with protection.

LEGEND	
C – Control	F – Fire Trouble Remote
S – Siren (Steady Output)	K – Contact
Y – Siren (Yelp Output)	R – Remote On/Off
D – Smoke Detector	P – Panic Button
● – Thermostat	RT – Remote On/Off With Tamper

FIGURE 1-1. Typical Installation Layout

NOTE: Refer to Section 4 for U.L. Listed System Requirements

1.2 Parts Diagram & Descriptions

FIGURE 1-2 details parts of the D1000 Control Series and their descriptions. These parts will be referenced in later sections of this manual.

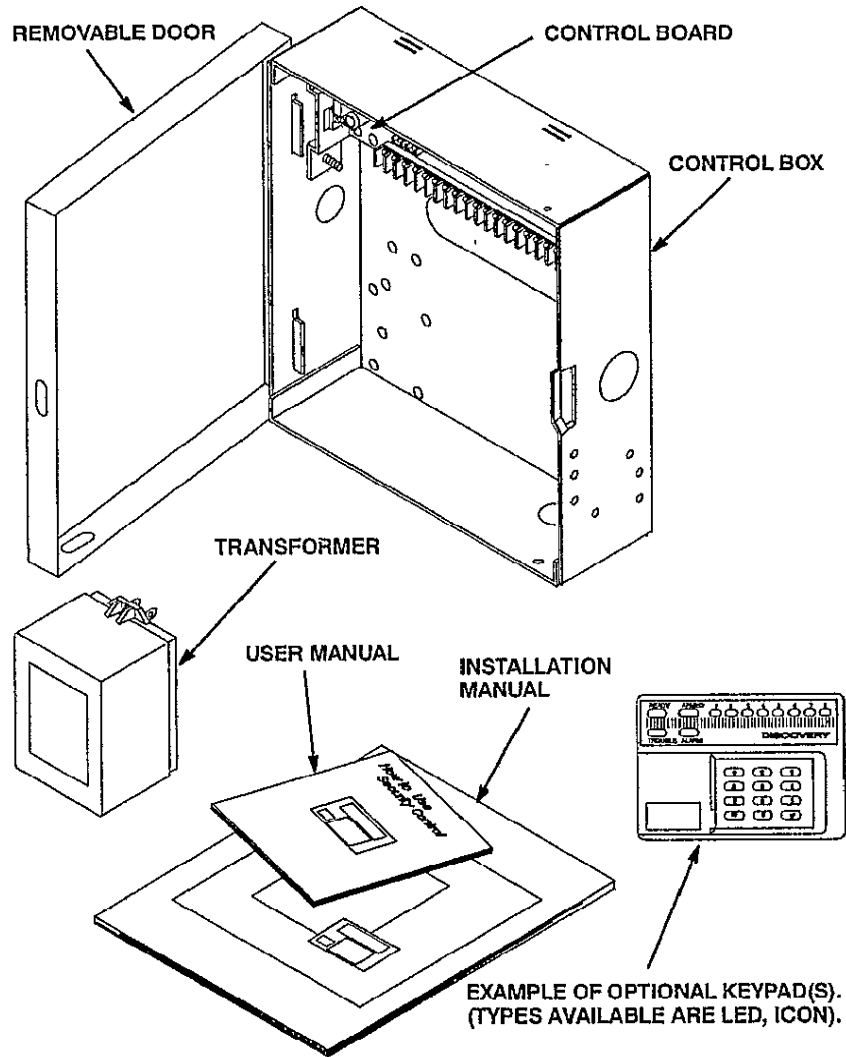

FIGURE 1-2. D1000 Parts List

1.3 Mounting And Wiring Preparation

Remove all packing material and compare the system components with those in FIGURE 1-2, page 1-3 to familiarize yourself with the part names. Mount the control in a secure, dry location where an ambient temperature inside the control box can remain at 32° to 120° Fahrenheit (0° to +49° Celsius). Remove control box knockouts that best suit your wiring needs and mount the control using the upper center slotted hole and two lower mounting holes. Install and connect all necessary wiring for the power transformer, detection loops, keypads and siren outputs. Refer to FIGURE 1-4, page 1-6.

1.4 Wiring

Earth Ground

In order for the control's lighting and transient protection to be effective, we recommend the control be connected to an earth ground. Finding a proper ground path can affect selection of the control mounting location since the ground wire should be as short and straight as possible.

An ideal ground for a security system is a unified earth ground. In this type ground, the power line, telephone, and security system ground rods are bonded together. This eliminates the possibility for Step Voltage Blowout, a frequent problem occurring during lightning strikes. Refer to FIGURE 1-3, page 1-5.

Reference NEC Article 250 for proper grounding requirements.

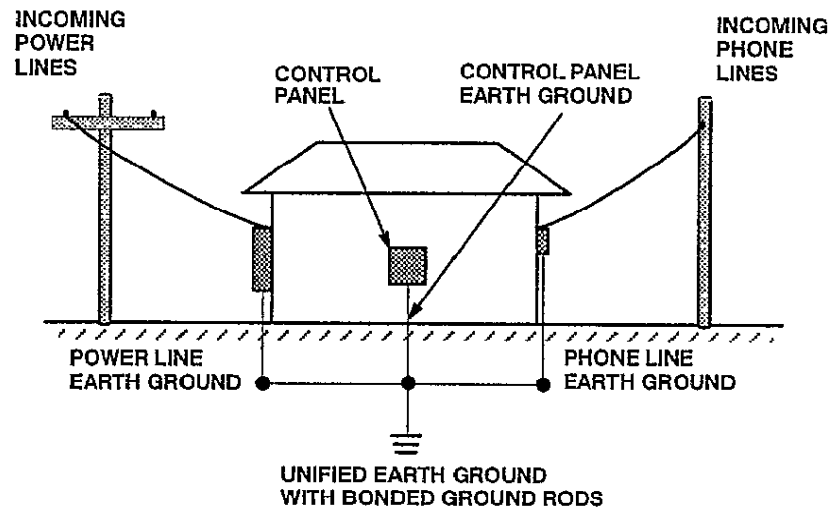
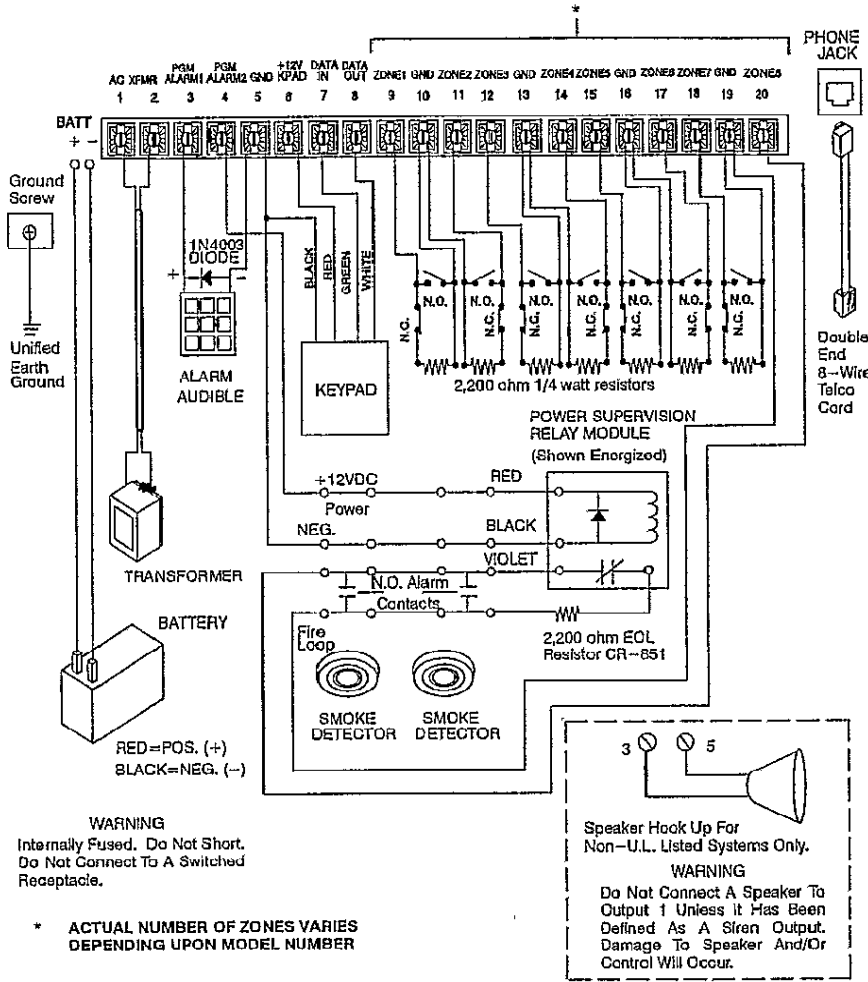

FIGURE 1-3. Unified Earth Ground

Follow these steps to earth ground the control:

1. Crimp the ground wire lug to the control end of a minimum 14 gauge solid ground wire.
2. Remove the lower left control board mounting screw, insert it through ground wire lug and re-install, securing the ground wiring.
3. Run the earth ground wire and attach to a bonded earth ground. Be sure to keep wire runs short and avoid 90° or sharp turns. Use a minimum radius of 8 in. for bends.
4. Remember, ground wires must be routed separately. Be sure to route toward the earth. Always use 8 ft. copper clad ground rods and never run parallel to metal without properly bonding to that metal.

I **Installation And Wiring**



- Battery** – 12V 4AH to 6AH, Voltage 13.6–13.8V, Max. Charge Current 400mA, Quiescent Charge Current 20mA
- Transformer** – 16.5V/25VA min. U.L. Class II 50/60 Hz.
- Smoke Detector** – ESL #445 AT U.L. Listed or Equivalent
- Power Supervision Relay Module** – U.L. Listed System Sensor Model A77-716 or Equivalent. One per each fire loop zone.
- Burglar/Fire Alarm Audible** – U.L. Listed Wheellock Horn #34T12 (85dB)

FIGURE 1-4. Suggested U. L. Household Burglar Alarm And/Or Fire (ff) Alarm Hookup (Shown With Zone 8 Defined As Fire)

Table 1-1. Control Board Terminal Descriptions

TERMINAL	FUNCTION	DESCRIPTION
1	AC Input	Connect 16.5 VAC 25 VA U.L. Class II transformer using 18 gauge minimum, 2 conductor wire. Do not exceed 50 feet. Do not plug in until all wiring is complete.
2	AC Input	
3	Programmable Alarm Output 1	(+) 10.0 - 12.2 VDC for powering devices upon alarm or other conditions as defined by Function 32.
4	Programmable Alarm Output 2	(+) 10.0 - 12.2 VDC for powering devices upon alarm or other conditions as defined by Function 33.
5	Common Negative	Negative termination for devices powered by terminals 3, 4, and 6. (Same as terminals 10, 13, 16, and 19.)
6	Keypad/Auxiliary Power 1 (+)	(+) 10.0 - 12.2 VDC for powering keypads, motion detectors, and other accessories.
7	Keypad Data In	Connect keypad green leads to this terminal.
8	Keypad Data Out	Connect keypad white leads to this terminal.
9	Zone 1 Loop (+)	Each loop requires a 2,200 Ω end-of-line resistor (Part #MPI-211). Closed or open circuit contacts can be connected to each loop. A common negative is shared between each group of two (2) zones. *Actual number of zones varies depending upon model number.
10	Zone 1 And 2 Common (-)	
11	Zone 2 Loop (+)	
12	Zone 3 Loop (+)	
13	Zone 3 And 4 Common (-)	
14	Zone 4 Loop (+)	
15	Zone 5 Loop (+)	
16	Zone 5 And 6 Common (-)	
17	Zone 6 Loop (+)	
18	Zone 7 Loop (+)	
19	Zone 7 And 8 Common (-)	
20	Zone 8 Loop (+)	

NOTE: Terminals 3 and 4 are overload protected at 2.5 amps (F2). Terminal 6 is overload protected at 1.0 amp (F1). Combined alarm condition current should not exceed 900 mA. Max. combined continuous current drain should not exceed 400 mA.

NOTE: Refer to Section 4 for U.L. Listed System Requirements

Standby Battery And Transformer

The control is powered by a 16.5 volt 25VA U.L. Listed Class II plug-in transformer. Follow the wiring instructions shown in FIGURE 1-4, page 1-6.

A 12 volt, sealed lead acid rechargeable battery (4 amp hour minimum) must be installed to provide primary power back up. The float charge voltage for the battery is set for 13.8 volts at 400 milliamps (mA) maximum, while the system is delivering its rated continuous output current. Current in excess of 400 mA can be delivered to the battery if the system is delivering less than the rated power. The battery charging current is limited through a 5 ohm resistor.

The battery automatically takes over and provides power in the event of an AC power outage. If the AC fails for an extended period and the battery voltage drops below 11.2 volts, the low battery detector will activate and cause the keypad pre-alarm to beep, the trouble indicator to light and the digital communicator to report to the central station (if so programmed). The beep can be silenced by pressing the Reset (*) key. Press and hold key 7 to clear the trouble indicator after the battery has been recharged.

If during a loss of AC power, the battery should drop below 7.5 volts, the microprocessor will shut down, but there will still be auxiliary equipment drain on the battery. An MPI-266 Low Battery Cutoff Module can be added to disconnect the battery and protect it against deep discharge.

1. To install the battery, place battery in enclosure. Make sure the AC transformer is disconnected.
2. Connect the black battery wire to the negative (black) battery terminal marked "-".
3. After wiring of the control is complete, connect the red battery lead to the positive (red) battery terminal marked "+".

CAUTION

A REVERSE CURRENT DIODE PROVIDES SOME PROTECTION TO THE ELECTRONICS IF THE POWER LEADS ARE ACCIDENTALLY REVERSED. DO NOT LEAVE LEADS REVERSED. OVERHEATING OF RESISTOR R8 WILL RESULT.

Hardwire Zone Inputs (Terminals 9 – 20)

The system provides up to eight (8) individually programmable class B end-of-line supervised detection zones depending upon model number. Each hardwired zone can be configured as a burglar, 24-hour Auxiliary A (Fire *ff*), 24-hour Auxiliary B (Holdup), 24-hour Auxiliary C or communicator report only zone. In addition, a single zone can be programmed to allow system key switch operation. Each of the zones can be further defined with various options and sub-options.

In order to function properly as a class B supervised circuit, a zone must have a 2,200 ohm 1/4 watt resistor installed at the end furthest from the control. This configuration allows both open and closed circuit contacts to be used on the same loop and provides a high degree of protection against compromise or tampering. The control constantly measures the resistance on a class B zone and is able to determine by a proper reading of approximately 2,200 ohms that a zone is secure and intact. It can respond differently to a high resistance (loop open) versus a low resistance (loop short).

For example, a class A Fire (*ff*) zone reacts with a supervisory/trouble condition when opened and an alarm when shorted. Supervisory/Trouble is a programmable sub option for each of the other zone types. There is even a choice of whether a trouble condition should occur upon an open or short (non-Fire zones only). The system comes equipped with eight 2,200 ohm, 1/4 watt resistors, one for each zone. The resistors are color coded with bands — red, red, red, and either gold or silver.

NOTE

Any loop short or open will greatly change circuit resistance and violate the zone. The resistor must be placed at the end of the loop.

Fire zones require use of U.L. Listed Model CR851 end-of-line resistor.

Connect a typical installation configuration as follows:

1. Connect all alarm sensors to the zone wiring as per the instructions provided by the individual sensor manufacturer and FIGURE 1-4 on page 1-6.
2. Connect each zone wire to the appropriately labeled terminals according to FIGURE 1-4. Each zone has an input terminal and a common (negative) return. Please note that a negative terminal is shared by two zones and that all negatives are common to each other.
3. If 12 volt D.C. powered detection devices such as motion sensors are being installed, refer to "12 VDC Outputs," on page 1-13.

24-Hour Auxiliary Zones

Zones defined as 24 hour Auxiliary A, Auxiliary B, or Auxiliary C are commonly used for Fire (*ff*), Holdup or Auxiliary C inputs, however, they can also be used for other devices requiring 24 hour supervision. A 24 hour Auxiliary A defined zone provides an alarm upon a loop short utilizing open circuit sensors and provides a supervisory/trouble upon an open or break in the loop. Auxiliary B and Auxiliary C defined zones can also be programmed with the supervisory/trouble sub-option.

24-Hour Communicator Report Zones

Communicator report only zones provide no keypad indication or panel outputs and are therefore intended for simply reporting conditions from temperature and/or water sensors.

Key Switch Zone

The system can be armed/disarmed with one or more momentary or maintained (shunt) contact key switch(es), however, only one zone may be programmed as a key switch zone.

When the momentary key switch is held closed for one second, the pre-alarm will beep to indicate that the key exchange is acknowledged. When the key switch closure is released, the control will arm/disarm. If program Function 305 is enabled, holding the key switch closed will change the interior on/off mode once each second, then after the interior status is displayed, releasing the key switch will arm the system. If programmed with the supervisory/trouble definition, a tamper switch can be wired to disable the key switch arm/disarm capability if the zone is violated.

If a zone is programmed for maintained key switch usage, the keypads will be disabled from either arming or disarming the control. Only the key switch defined zone can be used to arm or disarm.

NOTE

Do not define a maintained key switch zone for supervisory/trouble conditioning.

Keypad Wiring (Terminals 5, 6, 7, And 8)

The keypad connects to the control terminals using a four conductor cable. Four conductor, 22-gauge solid or larger jacketed cable is satisfactory for this hookup; however, stranded wire provides additional resistance to bending and breaking. A shielded cable with the control end connected to an earth ground provides additional protection from lightning. Connect the four keypad wires as indicated in Table 1-2 page 1-12.

The total number of keypads that can be used per system varies, depending upon the total current drain from terminals 3, 4, and 6. To determine the maximum number of keypads per system, add 50 mA for each keypad to be used. Maximum line resistance 47 ohms. This total should not exceed the limits as indicated in Table 3-1, page 3-4.

Table 1-2. D1000 Keypad Wiring

D1000 Series Keypad Wire Color	Function	D1000 Series Control Terminal
Black	Negative	5
Red	Positive (+12 VDC)	6
Green	Data In (Remote)	7
White	Data Out (Remote)	8

Troubleshooting

If a keypad is incorrectly wired, the following symptoms will appear.

- Red wire removed or cut: No keypad indicators. Sounder pulses rapidly. Keypad will not accept key entries.
- Black wire removed or cut: All keypad indicators flash rapidly. Sounder pulses rapidly. Keypad will not accept key entries.
- Green wire removed or cut: Trouble indicator lights steady. Keypad will not accept key entries.
- White wire removed or cut or green and white wires reversed: Keypad indicators scroll from left to right.

Overload Protection

F1

F1 is a 1.0 amp overload protector that protects terminal 6. In the event of an overvoltage spike, the keypad becomes inactive but the communicator, if programmed, will report a Low Battery/Output Overload condition to the central station.

F2

F2 is a 2.5 amp overload protector that protects terminal 3 and 4. In the event of an overvoltage spike, the keypads Trouble indicator will illuminate. Upon pressing and holding the 2 key for three seconds, the Zone 2 indicator (Low Battery/Output Overload) will illuminate. The communicator will report a Low Battery/Output Overload condition to the central station (if so programmed).



12 VDC Outputs

The control is supplied with two high power programmable outputs, two low power programmable outputs, and one auxiliary keypad power output. For U.L. installations, outputs 3 and 4 should only be used for supplementary devices.

Programmable Output 1 (Terminal 3, High Power)

Control terminal 3 is a +12 VDC terminal protected by overload protection F2 and is programmable using Function 32. This output can be programmed as a siren output, using the built-in driver. For a non-U.L. listed system, connect a 30 watt speaker from terminal 3 to negative terminal 5. (Refer to FIGURE 1-4, page 1-6.)

Programmable Output 2 (Terminal 4, High Power)

Control terminal 3 is a +12 VDC terminal protected by overload protection F2 and is programmable using Function 33.

Programmable Output 3 (Terminal P1, Connector J2)

Terminal P1 of Connector J2 is a +12 VDC terminal limited to 40 milliamps maximum and is programmable using Function 34.

Programmable Output 4 (Terminal P2, Connector J2)

Terminal P2 of Connector J2 is a +12 VDC terminal limited to 40 milliamps maximum and is programmable using Function 35.

Keypad Power/Auxiliary 1 (Terminal 6)

Keypad Power/Auxiliary 1 is used to supply +12 VDC power for keypads. This output is protected at 1.0 amps by overload protection F1. This output can also be used to supply auxiliary power for motion detectors and other devices provided the total current draw does not exceed limits set by Table 3-1, page 3-4.

Keypad Activated Panic Zones

The control has three keypad activated panic zones. Three panic keys are provided on the keypads (from left to right) for Auxiliary A (Fire ff), Auxiliary B (Holdup), and Auxiliary C alarms. Each zone is activated by pressing its designated key and holding for three seconds (or pressing at least twice within three seconds). If desired, the control can be programmed to respond to single momentary keypress by programming a value of 0 into Function 315.

Telephone Line Connection

The telephone line runs through a line seizure relay within the control. Whenever the control is idle, this relay completes the connection. When the control needs to communicate with the central station, this relay disconnects the house phones from the system, leaving only the communicator connected to the incoming lines. This prevents communication interruption caused by picking up of a house telephone within the protected premises. For proper installation and to meet FCC requirements, an approved USOC RJ-31X telephone jack and a mating 8 pin modular direct connect cord must be installed (see FIGURE 1-5 on page 1-15). This equipment provides isolation and disconnection points between the local telephone system and the control's digital communicator for telephone company troubleshooting. When ordering either jack, the telephone company will need the following information:

- Required jack: USOC RJ-31X
- The telephone number of the line where the jack is to be installed
- Requested location where jack is to be installed
- Digital communicator FCC registration number:
A79USA-74490-AL-E
- Ringer Equivalence: 0.0B

NOTE

The Ringer Equivalence Number (REN) is useful to determine the quantity of devices you can connect to your telephone line and still have all of those devices ring when your telephone number is called. In most cases, but not all areas, the sum of the RENs of all devices connected to one line should not exceed 5.0. To be certain of the number of devices suitable for connection to a line in your area as determined by the REN, contact the local telephone company. Refer to the inside back cover of this manual for FCC Compliance and additional telephone company information.

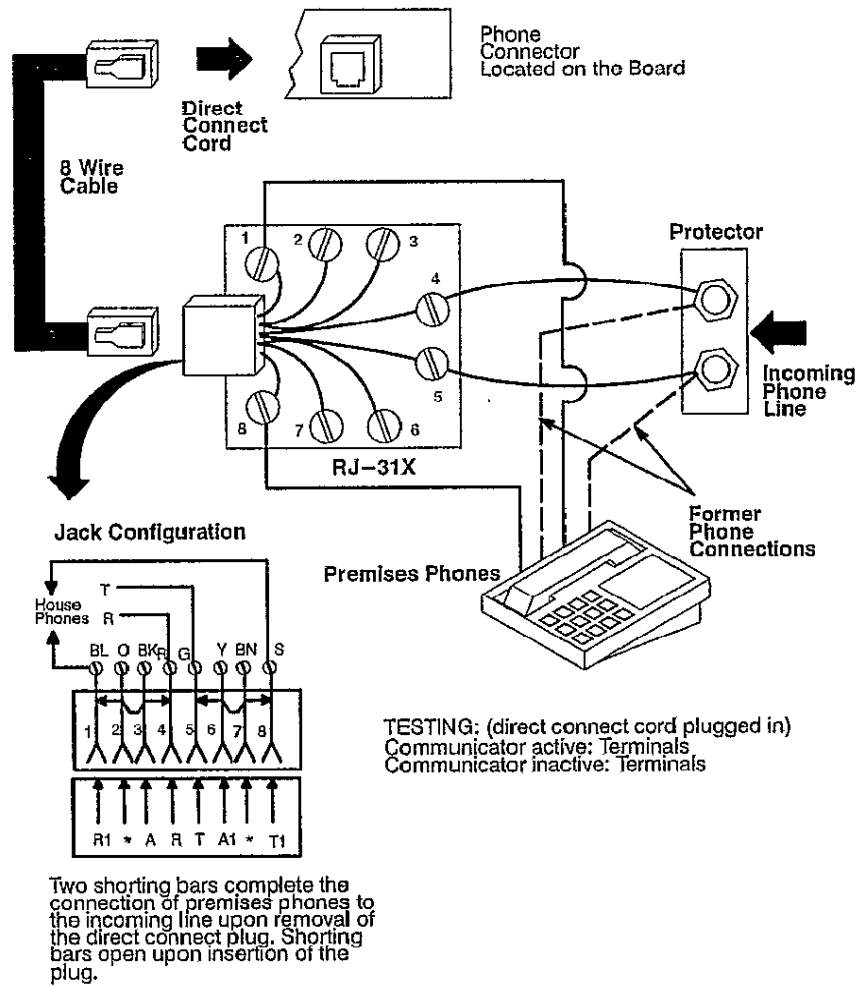

FIGURE 1-5. Telephone System Connection

THIS PAGE INTENTIONALLY LEFT BLANK

Operating The System **2**

2.1 Powering Up The Control

Before powering up the control, make certain that all connections are complete. This section assumes that the preceding sections have been read completely, that all wiring is complete, and the system is ready to be powered up.

Procedure

First, verify that the AC transformer and battery are connected. The control will power up with DC current only, but the Trouble indicator will light to indicate an AC Failure condition. The keypads will now display system status and emit a 2-second tone. If a keypad does not power up properly, pressing the Reset (*) key will reset the keypad microprocessor and allow it to begin working properly.

Watchdog Monitor

The watchdog monitor is a circuit that constantly monitors the operation of the microprocessor. If the control does not power up properly or if an internal problem occurs, the watchdog monitor will perform a restart of the microprocessor. Each time power is applied, a ROM and EEPROM check is automatically made and the system begins at the same operating condition it was in with the following exceptions:

- If the system is armed, the control will ignore all burglar defined zones for 15 seconds (or as programmed in Function 308) once the watchdog restarts the microprocessor.
- If the system is in alarm, the alarm output will cease and the control will re-arm.
- If the system is communicating, the communication will be lost with the exception of alarm reports. Alarms are stored in nonvolatile memory and will be re-transmitted.
- The automatic communicator test clock will be reset to zero. If the system is programmed for test reporting, the test report will be sent when the system resets, thus notifying the central station of an out of sequence test. The test time reporting code is optional and is disabled from the factory.

Automatic System Diagnostics Upon Power Up

Control panel memory is checked each time the control is armed/disarmed and during automatic communicator tests. If a memory error is detected, a trouble condition is annunciated by the control, either by scrolling LEDs or a continuous beeping at the keypad (the Trouble indicator will be illuminated). If an error is indicated, consult the Function Map to determine change(s) in information. Seek technical support from a qualified service technician as necessary. Keypad beeping can be silenced by pressing the Reset (*) key; the Trouble indicator will clear when program mode is exited.

Processing Alarms Following Total Power Loss

If a total power loss occurs (both AC and battery) while the control is armed, the control will ignore all burglar defined zones for 15 seconds once the power is restored. The delay is to allow time for devices such as motion detectors and glass break sensors to power up and stabilize. Delay time can be increased to 181 seconds (Function 308) if necessary to accommodate detectors requiring longer stabilization time. If a total power loss occurs while the digital communicator is transmitting, hardwire activated zone alarms stored in the EEPROM will be reported when power is restored.

NOTE

Keypad activated alarms as well as supervisory/trouble, opening/closings, restorals, cancellations, and test reports are not stored in EEPROM and therefore will be lost in the event of a total power loss.

2.2 The D1000 Series Keypad

The D1000 Series keypads were designed with ease of user operation in mind. A red "Armed" indicator blinks upon exit delay and lights steady when the control arms. A green "Ready" indicator lights steady if all hardwired zones are secure (even if faulted zones are shunted) and goes out if one or more zones are faulted. Each hardwired zone has a corresponding zone status indicator. If the green Ready indicator is off, the corresponding faulted zone indicator(s) will illuminate. If a zone is shunted, the corresponding zone indicator will blink, even if shunted by turning the interior defined zones off (see Interior ON/OFF). A separate Alarm indicator illuminates simultaneously with the alarmed zone indicator to provide alarm memory identification. A Trouble indicator lights if service is required. Arming and disarming is accomplished by entering a four digit code. Each code can include any digit sequence from 0001-9999. Up to eight User Authorization Codes can be programmed, one of these being the Master User Authorization Code. User Authorization Code one is the Master User Authorization Code. This code is also used to provide access to User Level Programming. Any code can be further defined as a High Security Arm/Disarm Code. When the system is armed with a High Security Arm/Disarm Code, the system cannot be disarmed by a non-high security code.

Keypad Power Up And Supervision

Upon installation and power up, each keypad should be initialized with the control by manually pressing the Reset (*) key. Then, if a keypad data wire is tampered with, poorly wired, or broken, or if a keypad is disconnected from the main control, the Trouble indicator on any remaining keypads will illuminate. Pressing the 2 key (on an active keypad) and holding for three seconds will cause the Zone 3 Supervisory indicator to light. The digital communicator can also be programmed to report this condition to the central station. If the faulted keypad still has power connected, the keypad indicators will scroll for local identification.

User Operation

Arming/Disarming

Arming and Disarming of the control is performed by simply entering an authorized four digit user code. Upon arming, the keypad sounder will beep during the programmable exit delay time (Function 15). Upon entering the premises through a delay defined zone, the keypad sounder will emit a steady pre-alarm tone during the programmed entrance delay

time (Functions 13 and 14). The entrance and/or exit delay annunciation can be disabled if desired by programming odd time values. The arm/disarm codes are also used to reset all Auxiliary alarms and keypad activated zones. User codes (Functions 1-9) are programmable only through User Level Programming.

Alarm Status

If an alarm occurs, the Alarm indicator remains lighted until manually reset. If the alarm was triggered through a hardwired zone, the corresponding zone indicators will also light. For example, if an alarm occurs on Burglar Zone 4, the Alarm Zone 4 indicators will illuminate. Upon disarming the control, these indicators will remain lighted. Pressing the Reset (*) key will turn the Alarm indicator off. If the alarm was triggered through one of the keypad activated zones, the red Alarm indicator will light. Entering a valid user code will clear the alarm.

Manually Resetting Alarms

Burglar alarms: The burglar alarm can be reset by entering a valid user code. The communicator will continue to report the condition to the central station as programmed unless programmed to abort upon disarming. The Alarm indicator will remain lighted until reset by pressing the Reset (*) key.

Auxiliary A (Fire ff) Alarms: Pressing the Reset (*) key will silence the keypad sounder. The Auxiliary A (Fire ff) alarm which can be provided through the Programmable Output will also cease. The Alarm indicator will remain illuminated and the communicator (if programmed) will continue to report to the central station. Entering a valid user code will clear the alarm.

Auxiliary B (Holdup) Alarms: Pressing the Reset (*) key will silence the keypad sounder. The Auxiliary B (Holdup) alarm, which can be provided through the Programmable Output will not be reset by pressing this key. Entering a valid user code will reset the alarm.

Auxiliary C Alarms: Pressing the Reset (*) key will silence the keypad sounder. The Auxiliary C alarm, which can be provided through the Programmable Output will also cease. The Alarm indicator will remain illuminated and the communicator (if programmed) will continue to report to the central station. Entering a valid user code will reset the alarm.

Keypad Activated Panic Zone Operation

The control has three keypad activated zones. Each zone is predefined for the type of alarm it can initiate and is activated by pressing a designated key. For added protection against false alarms, the control is programmed to ignore momentary keypresses and requires a three second maintained keypress (or at least two momentary key presses within three seconds). The panic keys are located behind a hinged door. The top key is predefined to initiate an Auxiliary A (Fire *ff*) alarm, the center key can initiate an Auxiliary B (Holdup) alarm, and the bottom key an Auxiliary C alarm. Self adhesive labels are included with the keypad for labeling these keys with symbols. Any or all keypad zones can be disabled through programming. Programmable Outputs can be programmed to provide + 12 VDC upon activation, and the communicator can also be programmed to report (refer to Table 2-1 on page 2-8).

When a keypad zone is activated, the keypad beeps and the Alarm indicator lights. The keypad can be silenced by pressing the Reset (*) key. If the zone is defined as an Auxiliary A or C zone, pressing the Reset (*) key will also silence the assignable output (terminal 3) if so assigned. The alarm can be reset by entering a valid user code. The keypad activated zone can be programmed to report the alarm to the central station. Auxiliary B can be programmed to be visually and audibly silent at the keypad when activated.

Zone Shunting (Bypassing)

Hardwired burglar zones can be manually bypassed by pressing the Bypass (#) key followed by the number of the zone to be shunted. Auxiliary A, B, and C, zones can be defined with the sub-option to allow them to be shuntable also. The control must be disarmed for shunts to be enabled. When zones are shunted, the appropriate Zone indicators will blink continuously. Pressing Bypass (#) followed by the number of a shunted zone will remove the shunt. Pressing Bypass (#) followed by 9 will remove all shunts. When the control is armed, the shunted zone indicators will only blink for the first 30 seconds after the exit delay expires. Zone shunting is disabled through programming.

READY INDICATOR

If ON: The system is ready to be armed.

If OFF: The system is not ready to be armed. One or more unshunted zones are not secure.

ARMED INDICATOR

If ON: Burglar system is armed.

If OFF: System is disarmed.

If BLINKING: Exit delay is active. Indicator will light steady when the control arms.

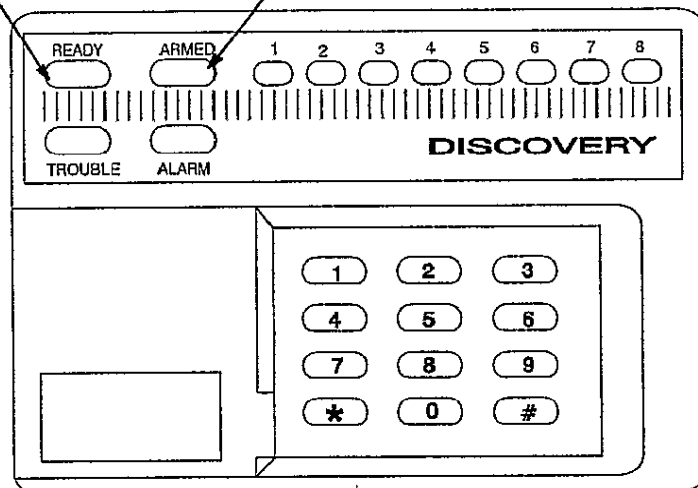

FIGURE 2-1. D1000 Series Keypad Indicators

Installer Diagnostic Features

Certain keypad keys provide access to special features designed primarily for use by the installer. However, the installer can at his or her discretion, explain certain available features to the user when necessary. Table 2-2 on page 2-9 lists these features. Diagnostic information is obtained through the keypad by pressing specific keys. Information is displayed through combinations of illuminated indicators. Features accessed through keys 4, 5, 6, 7, 8 and Reset (*) can be disabled through installer programming. Table 2-1 on page 2-8 aids in defining specific trouble conditions.

Identifying Trouble Conditions

If a trouble condition exists, a Trouble indicator will illuminate on the keypads. Pressing and holding the number 2 key for three seconds will cause one or more of the zone indicators to light. Each zone indicator corresponds to a specific Trouble condition. This procedure is simple enough to be performed by the user and communicated to the installer over the telephone for diagnosis. Table 2-1 explains the indicated conditions.

If the Trouble indicator is lighted, press and hold the 2 key for three seconds. The keypads will beep three times and one or more zone indicators will light to indicate the nature of the Trouble condition as explained in Table 2-1.

Alarm Memory Retrieval

When an alarm condition occurs, the control stores a record of the alarm in memory. This information can be retrieved even after the alarm has been reset and the keypad Alarm indicator is extinguished. To obtain a display indicating the most recent alarm, press and hold the 3 key for three seconds and observe the lighted indicators. The display will return to the normal status mode after eight seconds.

Event History Buffer

The control features a built-in 20 event buffer which can be viewed through the upload/download software.

Table 2-1. Trouble Definition

LIGHTED INDICATOR	INDICATED CONDITION/CORRECTIVE ACTION
Zone 1	AC Power Failure. Check transformer terminals 1 and 2 for presence of 16.5 VAC (no load) power.
Zone 2	Low Battery/Overload Protection. Check F1, F2, and condition of standby battery.
Zone 3	Supervisory/Trouble. A supervisory defined zone is shorted or open.
Zone 4	Fail To Communicate. The control attempted to communicate with the central station but failed. Press the "Reset (*)" key to silence the keypad sounder.
Zone 5	Memory Error. Program information stored in the EEPROM has changed. See "Powering Up The Control".
Zone 6	Missing Keypad. A keypad data wire has been removed from the control.
Zone 7	None
<i>The following conditions do not require the "Trouble" indicator to be lighted. Press the 2 key and hold for three seconds in the same manner as above to obtain the following ON or OFF indications:</i>	
Zone 8	Chime ON. The chime (monitor) feature is active.
Alarm	None
Ready	Interior OFF. The interior defined zones are turned OFF (bypassed). They can be reinstated by pressing and holding the number 4 key for three seconds. Turning the interior off can also automatically disable the entrance delay, if so programmed (Function 311).
Armed	Delay OFF. The Entrance Delay assigned to Entrance Delay 1 and 2 defined zones has been turned OFF. Delay can be reinstated by pressing and holding the 5 key for three seconds.

Table 2-2. Special Keypad Features

KEY NUMBER	FEATURE PROVIDED
2	Trouble Status: If a problem exists within the system, a keypad indicator labeled "Trouble" will light. Pressing and holding this key for three seconds further defines the trouble. This function ends automatically after 8 seconds.
3	Alarm Memory: Pressing and holding this key for three seconds will obtain a display identifying the zone that triggered the last alarm condition. Programming Function 011 clears Alarm Memory.
4	Interior ON/OFF: All interior defined zones can be shunted by pressing and holding the number 4 key for three seconds. Corresponding zone indicators will blink to indicate zones are shunted. These zones can be returned to operation by repeating the process. Entrance delay can be disabled whenever the interior is turned off depending upon programming of Function 311. Zones can be automatically defaulted to on or off (along with the delay if so programmed) depending upon programming of Function 310. The Interior ON/OFF key is disabled through Function 320.
5	Delay ON/OFF: All delay defined zones can be made instant by pressing and holding the 5 key for three seconds. Key 5 can be disabled using Function 320.
6	Chime: Pressing and holding the number 6 key for three seconds will activate the Chime (Monitor) feature. The keypads will beep three times to signify that the chime has been turned on. When enabled, the keypads will beep twice whenever a perimeter burglar defined zone is violated (with the control disarmed). The chime feature can be disabled through programming (Function 321) if desired.

Table 2-2. Special Keypad Features (Cont'd)

KEY NUMBER	FEATURE PROVIDED
7	Switched Power Interrupt: Pressing and holding this key for three seconds will cause the control to temporarily interrupt the power from one of the high powered outputs which has been programmed as smoke reset. Switched power will be interrupted for five seconds, in order to reset smoke detectors and other latching devices. This feature can be disabled through programming (Function 322). Key 7 is also used for clearing a Low Battery Trouble Indicator.
8	Test: Press and hold this key for three seconds to enter the Test mode. Each time a zone is violated, the corresponding indicator will remain lighted until manually exiting this mode. This allows for a "tally" of zones tested. This mode is exited by pressing and holding the 8 key once again or pressing the "Reset (*)" key. The manual test feature can be disabled through programming (Function 323).
9	Program: Press and hold for three seconds, then enter the Master User Code to enter the User programming mode. See Programmer's Manual for more information.
0	Access: Press and hold for three seconds, then enter assigned user code to provide output for Access. User code must be assigned a configuration digit of 2, 3, 5, or 7 (Function 024-031).
*	Reset: Used to clear/reset improper key entries/alarms.
#	Bypass (Zone Shunting): Zones can be bypassed by pressing the "Bypass (#)" key followed by the zone number (1-8). Pressing "Bypass (#)" then 9 clears all shunts. This feature is disabled through Function 319.

D1000 Specifications

3

3.1 Technical Specifications

- Max. of 8 two-wire zones each supervised with a 2,200 ohm end-of-line resistor. Actual number of zones varies depending upon model number.
- 3 keypad activated zones.
- Nominal current drain for control board only: 42 mA.
- Watchdog microprocessor monitoring circuit.
- Superior 4 stage lightning/transient protection.
- 4 programmable current outputs.
- Automatic system shutdown if voltage falls below 7.5 volts.
- Operating temperature range inside the enclosure: 32° F to 120° F (0° C to 49° C).
- Operating voltage range: 10.0 – 12.2 VDC residential.
- Regulated 13.8 VDC 400 mA continuous output. (See Section 5 for U. L. and C.S.F.M. limits.)
- Reverse polarity protection on battery inputs.
- Float charging circuit: 13.8 VDC.
- Overload protection for Programmable Alarm outputs 1 and 2 at 2.5 amps. Overload protection for Keypad/Aux. 1 output at 1.0 amps.
- 400 mA continuous regulated, 900 mA under alarm condition.

Recommended Battery:

- Rechargeable 12 volt 4 amp-hour or 12 volt 6 amp-hour sealed lead acid.

Transformer:

- U.L. listed class II plug-in, 16.5 VAC, 25 VA secondary, 120 volt 60 Hz primary.

Enclosure:

- 20 gauge metal cabinet with knockout for optional cam lock. Dimensions: 9" W x 10" H x 2.875" D (228.6mm x 254mm x 73.02 mm).

Power Supply:

- Low voltage detection monitoring @ 11.2 volts threshold.
- Less than 200 millivolts AC ripple.

Digital Communicator:

- Touchtone* or Rotary (pulse) dialing. Rotary speed: 10 pps, (selectable 60% break, 40% make or 66% break, 33% make).
- FCC Registration: A79USA-74490-AL-E. Ringer equivalence: 0.DB
- Transmission formats include: Slow (10 or 15 baud), fast (20 or 40 baud), Radionics superfast (30 baud), BFSK ®, and Modem II ®.
- Reports to most major central station receivers.
- Primary and secondary phone numbers up to 16 digits.
- Dual reporting capability.
- Three emergency panic zone keys.
- Mounts to any standard single gang electrical box.
- Indicators provide total system and zone status.
- Built-in piezo sounder.
- Nominal current drain: 20 mA all indicators off, 60mA all indicators and piezo sounder on.
- Up to 7 per system. (See Section 5 for U.L. and C.S.F.M. limits.)
- Size: 4.55" H x 6.80" W x .90" D (115.57mm x 172.72 mm x 22.86 mm)
- Color: Bone white with gray labeling.

Keypads:

- Color coded 4 wire hookup.
- Twelve button keypad with audible and tactile feedback.

Listings And Approvals:

Household Burglary – U.L. 1023.
 Household Fire – U.L. 985.
 Household Burglary/Fire – U.L. 985/1023

3.2 Features

- Ready to install with a factory basic program.
- Upload/Download programming and control from a remote location using an IBM PC ® or compatible, a Hayes ® modem, and TRANSPORT-PC software.
- 8 user authorization codes.
- Programmable communicator lockout of burglar defined zones to limit runaway reporting.
- EEPROM memory retains arm/disarm status, alarm memory and programming after total power loss.
- Self-diagnostics with memory error detection and reporting.

- 8 hardwire zones programmable as burglar, 24 hr. Auxiliary "A" (fire *ff*), Auxiliary "B" (holdup), and Auxiliary "C", and communicator report only.
- 3 keypad activated panic zones.
- A single zone can be programmed for keyswitch arm/disarm.
- Burglar zones can be defined as instant or delay (2 delay timers), interior or perimeter, silent instant, priority (non-shuntable), slow or fast loop response.
- All hardwire zones can be programmed for supervisory/trouble condition latching or momentary.
- Individual or group zone shunt (bypass) from keypad.
- Zone force arm with full shunt, or restore when zone restores.
- 24 hour zones can be programmed as shuntable.
- Programmable Timers: Entry Delay 1 and 2, Exit Delay, Access, Alarm Cut-off, and Delay before audible burglar alarm output.
- Programmable loop response of 40 msec. to 10 seconds.
- Eight (8) second invalid or inactive control station timeout and 3 minute programming timeout.
- Continuous monitoring of overload protection devices.
- Optional siren/bell test upon arming.
- Optional timed or latched access (door strike) output.
- Missing keypad detection with communicator report.
- Digital Communicator Reporting Capabilities:
 - 3 or 4 digit account codes.
 - 1 or 2 digit alarm codes.
 - Report by zone.
 - Single or 2 line extended.
 - Two separate Account Codes.
 - Hexadecimal reporting.
 - Dual reporting.
 - Split reporting.
 - Opening or Closings by User Code.
 - Shunted zone(s) reported upon arming.
 - Exception openings by User Code.
 - Individual zone and or system restore.
 - Cancel/Abort report by User code.
 - Supervisory/trouble by zone.
 - Low battery and battery restoral.
 - AC failure and AC restoral.
 - Automatic test every 12 hours or 1 to 7 days.
 - Delay before dial.
 - Dial attempts for telephone number one and two.
 - Optional fail-to-communicate annunciation.

3.3 Optional Accessories

- **TRANSPORT-PC:** Upload/Download software package.
- **Z232 Relay/Ground Start Module ††:** For use with ground start phone lines.
- **MPI-266 Low Battery Cutoff Module ††:** Automatically disconnects battery to prevent deep discharge if battery voltage drops below 7.5 volts.

Table 3-1. Configurations And Current Drain Provisions

Application	Listing	Maximum Current Drain (milliamps) With 4AH Battery	Minimum Standby Time In Hours	D1000 Control Stations	E.S.L. Smoke Detector Model 445AT. System Sensor Supervision Module Model A77-716	Auxiliary Equipment Required
Non U.L. Listed C.S.F.M Approved		400	3 4	7 6	N/A Required	Wheelock 34T-12 Horn
Household Burglary	U.L. 1023	400	4	6	N/A	Amseco MSB-10G Bell
Household Fire (ff)	U.L. 985	400	4	6	Required	Wheelock 34T-12 Horn
Household Burglary/Fire (ff) Combination	U.L. 1023/985	400	4	6	Required	Amseco MSB-10G Bell and Wheelock 34T-12 Horn

Maximum combined continuous current drain (standby) refers to terminals 3, 4, 6, and Connector J2. Under Alarm conditions, the combined output current drain should not exceed 900 mA.

†† Not A U.L. Listed Device

U.L. And N.F.P.A. Requirements

4

4.1 Underwriters Laboratories (U.L.) Listing

- U.L. 1023 Household Burglary
- U.L. 985 Household Fire (*ff*)
- U.L. 1023/985 Household Burglary/Fire (*ff*) Combination.

4.2 National Fire Protection Association (N.F.P.A.) Rules

The National Fire Protection Association (NFPA) has established rules to follow pertaining to fire prevention and the installation of fire detection equipment.

Smoke Detector Location

Smoke detectors should be installed in accordance with the NFPA standard 74. FIGURE 4-1, page 4-2 illustrates detector placement.

The following is from NFPA 74: Smoke detectors shall be installed outside of each separate sleeping area in the immediate vicinity of the bedrooms and on each additional story of the family living unit including basement and excluding crawl spaces and unfinished attics. For family living units with one or more split levels, (i.e., adjacent levels with less than one full story separation between levels), a smoke detector required by the above shall suffice for an adjacent lower level, including basements.

Exception: When there is an intervening door between one level and the adjacent lower level, a smoke detector shall be installed on the lower level.

Ceiling mounted smoke alarms should be located in the center of the room or hall, not less than 4 inches from any wall. When the detector is mounted on a wall, the top of the detector should be 4 to 12 inches from the ceiling.

Do not install smoke alarms where normal ambient temperatures are above 100° F (38.7° C) or below 40° F (4° C).

Also, do not locate smoke detectors in front of air conditioners, heating registers, or other locations where normal air circulation will keep smoke from entering the detector.

Heat from a fire rises to the ceiling, spreads out across the ceiling surface and begins to bank down from the ceiling. The corner where the ceiling and wall meet is an air space into which heat has difficulty in penetrating. In most fires this dead air space measures about 4 inches (0.1 m) along the ceiling from the corner and 4 inches (0.1 m) down the wall as shown in FIGURE 4-1. Heat or smoke detectors should not be placed in this dead air space.

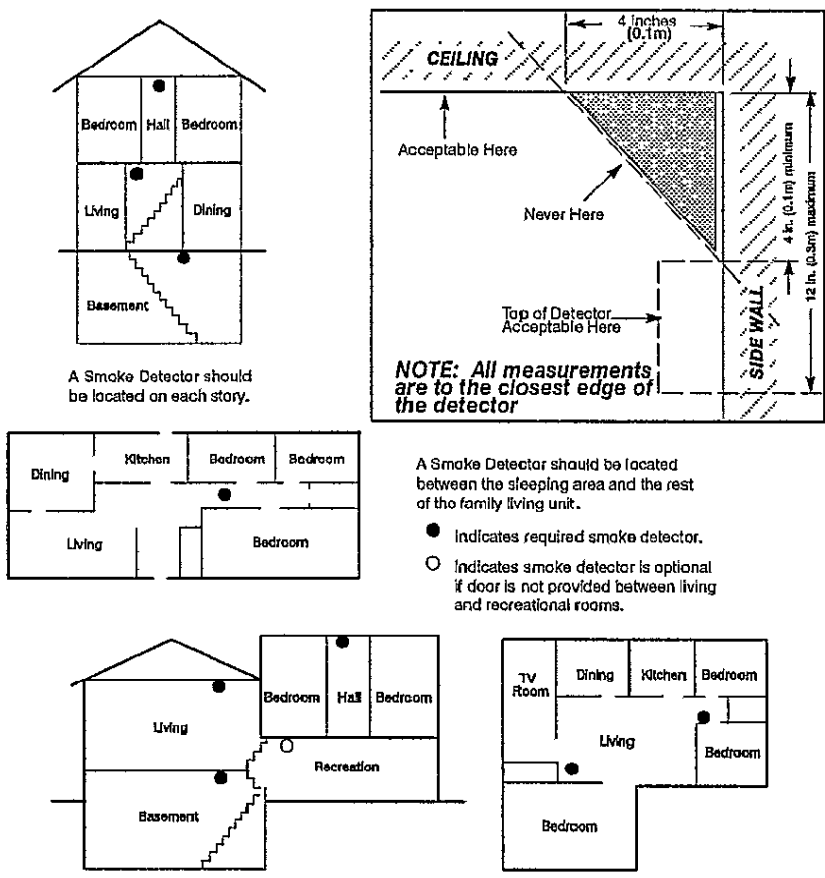

FIGURE 4-1. Smoke Detector Placement

Index

A

Accessories, Optional, 4-4

B

Battery, 1-8

Burglar, Installation Layout, 1-2

D

Diagnostics, 2-7

F

Features, 3-2

Keypad, 2-9, 2-10

Fire, Installation Layout, 1-2

K

Keypad, 2-3

Diagnostics, 2-7

Features, 2-9, 2-10

Indicators, 2-6

Operating, 2-3, 2-4, 2-5

Wiring, 1-11, 1-12

L

Layout, Installation, 1-2

Listings And Approvals, 3-2

M

Mounting And Wiring, 1-4

N

National Fire Protection Association
(N.F.P.A.), 4-1

O

Outputs, 12 VDC, 1-13

Overload Protection, 1-12

P

Parts, 1-3

Power Loss, 2-2

Power Up, 2-1

S

Smoke Detectors, 4-1

Specifications, 3-1

Configurations And Current
Drain Provisions, 3-4

T

Technical Specifications, 3-1

Telephone, 1-14

Terminal Descriptions, 1-7

Troubleshooting, 2-8

FCC COMPLIANCE

This equipment generates and uses radio frequency energy and if not installed and used properly and in strict accordance with the manufacturer's instructions, may cause interference to radio and television reception. It has been type tested and found to comply with the limits for a Class B computing device in accordance with the specifications of subpart J or part 15 of FCC rules, which are designed to provide reasonable protection against such interference in a residential installation. However, there is no guarantee that interference will not occur in a particular installation. If this equipment does cause interference to radio or television reception, determined by turning the equipment off and on, the user is encouraged to try to correct the interference by one or more of the following measures:

1. Reorient the TV or radio antenna.
2. Relocate or move the alarm control away from the receiver.
3. Plug the transformer for the alarm control into a different outlet so that the receiver and the alarm are on different branch circuits.
4. If necessary, the user should consult the alarm dealer or an experienced radio/television technician for additional suggestions.
5. The user may find the following booklet prepared by the Federal Communications Commission helpful: "How To Identify and Resolve Radio-TV Interference Problems." This booklet is available from the U.S. Government Printing Office, Washington, DC 20402 stock #004-000-00345-4. This equipment complies with Part 58 of the FCC rules.

ADDITIONAL TELEPHONE COMPANY INFORMATION

The security control panel must be properly connected to the telephone line with a USOC RJ-31X telephone jack and a matching 8 pin modular "Direct Connect Cord."

The FCC prohibits customer-provided terminal equipment be connected to party lines or to be used in conjunction with coin telephone service. Inter-connect rules may vary from state to state.

INCIDENCE OF HARM

In the unlikely event that the communicator should ever cause harm to the telephone network, the telephone company will notify the telephone subscriber that temporary discontinuance of service may be required; however, where prior notice is not practical, the telephone company may temporarily discontinue service. In the case of temporary discontinuance, the telephone company shall promptly notify the telephone subscriber who will be given the opportunity to correct the situation. The customer also has the right to bring a complaint to the FCC if he feels the disconnection is not warranted.

If your telephone equipment causes harm to the telephone network, the telephone company may discontinue your service temporarily. If possible, they will notify you in advance, but if advance notification is not practical, you will be notified as soon as possible. You will be notified of your right to file a complaint with the FCC.

CHANGES IN TELEPHONE COMPANY EQUIPMENT OR FACILITIES

The telephone company may make changes in its communications facilities, equipment, operations or procedures, where such action is reasonably required and proper in its business. Should any changes render the communicator incompatible with the telephone company facilities, the customer shall be given adequate notice to make modifications to maintain uninterrupted service.

NOTIFICATION

All connections to the telephone network must be made through standard plugs and standard telephone company jacks, or equivalent, in such a manner as to allow for easy and immediate disconnection of the alarm equipment. If the connecting cord is unplugged from the jack there shall be no interference to the telephone equipment still connected to the telephone network.

Notify the telephone company if the communicator is removed from the premises and the RJ31-X jack is no longer needed.

MALFUNCTIONS OF EQUIPMENT

In the unlikely event that the system should ever fail to operate properly, it should be disconnected from the RJ31-X jack to determine if the problem is with the telephone network or with the security system. If a problem is found with the communicator, leave disconnected until repaired or replaced.

If you experience trouble with the telephone equipment, please contact the manufacturer for information on obtaining service or repairs. The telephone company may ask that you disconnect this equipment from the network until the problem has been corrected or until you are sure that the equipment is not malfunctioning.



64812578A